

Introduction to RF Design

White Paper

Products:

- Spectrum Analyzers
- Signal Generators
- Vector Network Analyzers
- RF Power Meters / Sensors

This white paper is the first in a series with a goal of providing practical knowledge on the entire process for designing an RF system.

Today there are many wireless technologies that utilize RF design ranging from mobile phones to satellite TV to wireless Internet connections and Bluetooth devices.

This material is intended to provide insight into how these technologies work and considerations during the design, development and verification process.

Table of Contents

1	A Simplified Communication System	3
2	RF Fundamentals.....	4
2.1	Spectrum Allocation.....	5
2.2	Wavelength Matters.....	6
2.3	Reflections and Interference	7
2.4	Determining Power Using dBs	8
3	System Design Blocks	9
3.1	Transmitters	9
3.2	Receivers	10
3.3	Antennas.....	11
3.4	Putting It All Together	12
4	Components.....	13
4.1	Filters	13
4.2	Amplifiers	14
4.3	Mixers.....	15
4.4	Modulators/Demodulators	15
5	Test and Verification Instrumentation.....	16
5.1	Spectrum analyzers.....	16
5.2	Signal Generators	16
5.3	Vector Network Analyzers	17
5.4	RF Power Meters.....	17
6	Conclusion	18

1 A Simplified Communication System

Let's start with the basic blocks of a typical communications system (Figure 1). Basically any system will include an information source, information processing, the transmitter, transmission medium, a receiver, and then again information processing, and information destination. In the early days the signal was primarily voice, but of course today data is a major part of the communicated information.

The information processing is taking the source information and putting into a format which can be transmitted over whatever medium is required. In a wireless or RF system, we're typically communicating through free space or air, as opposed to through a wire or a fiber network.

In the early days of RF design it was more common to have a one-way path for the RF signals. Radio and television are good examples. These signals were transmitted via large antennas to many radios and televisions. Today's mobile phone is a great example of a more common device which is able to both transmit and receive signals. This paper focuses on transmit and receive portion of an RF communication system, discusses the key components, and test equipment to ensure performance verification.

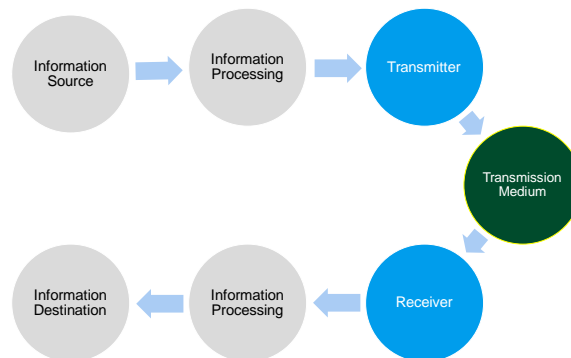

Figure 1. Simplified Communications System Block Diagram

2 RF Fundamentals

In the early days of wireless communications signals were basically sine waves. Remembering back to our school days that a sine wave can be represented with a frequency, an amplitude, and a phase.

$$V = A \sin(\omega t + \phi)$$

where A = amplitude
 $\omega = 2\pi f$, where f is the frequency
 ϕ = phase

Figure 2 shows two signals in the time domain. In terms of our communications the intent is to send information from a source to a destination by modifying these sine waves. Today of course it is more common to have modern digital signals that are transmitting higher data rates with a signal that is much more complex.

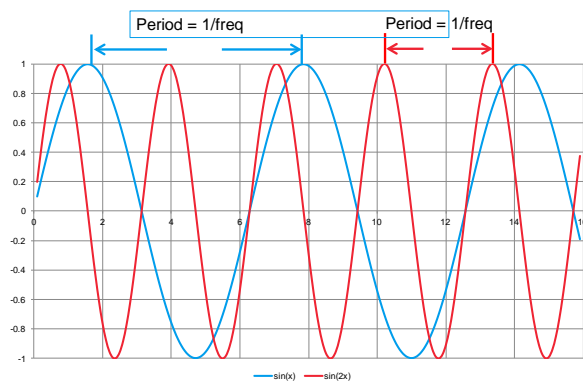

Figure 2. Basic sine waves are used to carry information by varying their frequency, amplitude, and/or phase.

Typically, in terms of RF and microwave signals, we tend to look more in the frequency domain than in the time domain. Figure 3 shows a basic signal on a spectrum analyzer display. As the transmitted signals become more complex modulated signals or signals with more information put on them, the spectrum analyzer displays are excellent for understanding the multiple frequencies and modulation techniques.

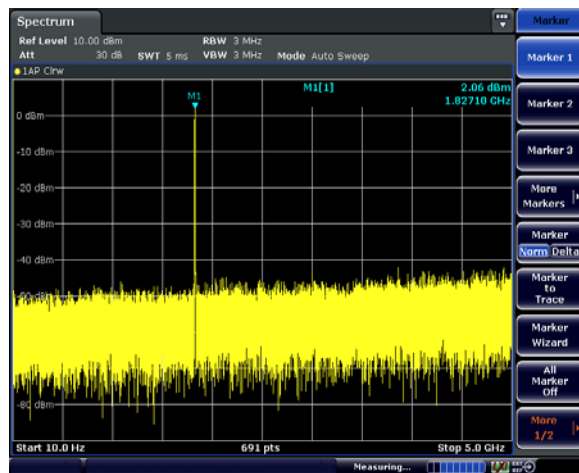

Figure 3. Spectrum analyzers are excellent tools for evaluating transmitted RF and microwave signals.

2.1 Spectrum Allocation

The Federal Communications Commission or FCC both defines and allocates the frequency spectrum in the United States. Similar government bodies around the world do the same for their countries and regions. Figure 4 shows the spectrum allocation chart for the US.

The local governing body, such as the FCC, decides who gets to transmit what, over what frequencies, what power levels and how much bandwidth they get to do it. When designing a wireless system all radiating devices must adhere to their portion of the frequency allocation table. Many aspects of the spectrum have been defined for a long time. Other areas, such as the old analog TV bands have become available as countries have moved to new digital TV bands. It is important to note that the spectrum allocation varies across countries. For instance, emergency responder equipment from one country may not work in another country. Commercial wireless solutions like Bluetooth and Wi-Fi must be carefully coordinated among countries and manufacturers to ensure devices work in different regions.

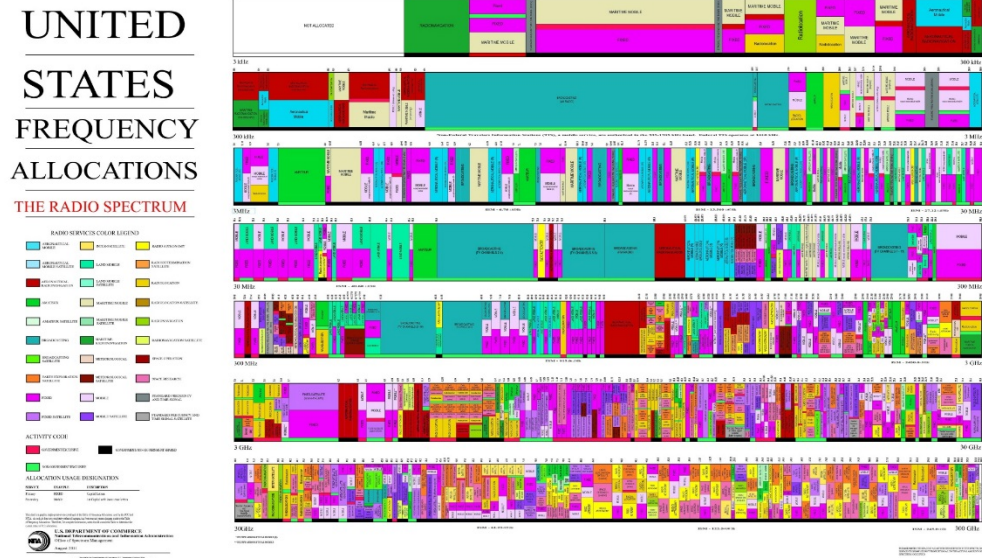

Figure 4. Each country or region defines and allocates the frequency spectrum for use by various groups and applications.

2.2 Wavelength Matters

Frequency is a critical parameter in RF design. Early applications were focused on audio frequencies, now referred to as analog systems. While there still are plenty of audio devices in use, there has been a broad increase of RF applications such as mobile phones, Bluetooth devices and Wi-Fi. Today, there are many commercial applications that use microwave and even millimeter wave frequencies.

Table 1 highlights the fact that as the frequency increases, the wavelength decreases. The effects of wavelength on a design can have implications on design complexity and end product costs. First let's look at how to determine the wavelength:

$$\lambda = \frac{v}{f}$$

where λ = wavelength
 v = phase velocity, which in free space is 3×10^8 m/s
 f = frequency

Table 1. Examples of Wireless Applications and Their Wavelengths

Application	Frequency	Wavelength (metric)	Wavelength (English)
AM Radio	1000 kHz	300 m	968 ft
FM Radio	100 MHz	3 m	9.7 ft
Wi-Fi, 802.11	2.4 GHz / 5 GHz	125mm / 60 mm	5.9 in / 2.4 in
Automotive Radar	77 GHz	4 mm	0.15 in

So how does wavelength affect the RF design? When you consider the device size relative to wavelength the physical geometry may become an important consideration. From the signals in Figure 5 we see that the sine wave starts at zero, it goes up to a maximum, comes back down to zero, goes to a minimum, and come back up to zero across a single wavelength. From Table 1, we can see that at audio frequencies this happens across a distance of meters to hundreds of meters. The phase effects of moving through a typical analog device are therefore minimal. However, as you move into RF frequencies or higher, the effect of these phase variations becomes a design consideration. Certain circuit design techniques take advantage of $\lambda / 4$ and $\lambda / 2$ effects to optimize or cancel signals, which is really a way to minimize the effects of the topic in our next section.

2.3 Reflections and Interference

As the sine wave propagates down a transmission line or a cable, what happens when it hits a discontinuity or some change in impedance? This typically occurs at a connector or a solder point or even changes in the widths of a transmission line. Figure 5 shows a signal that is propagating down a transmission line and hitting a discontinuity represented by a green box. While some percentage of that signal will pass through the green box, some of the signal is reflected back.

This reflected signal will add in and out of phase depending on the phase of the signals. The red sine wave that's reflecting back could be completely out of phase with the incoming signal and could actually cancel out the signal. These effects need to be analyzed and mitigated when designing your transmission lines and circuit boards at higher frequencies.

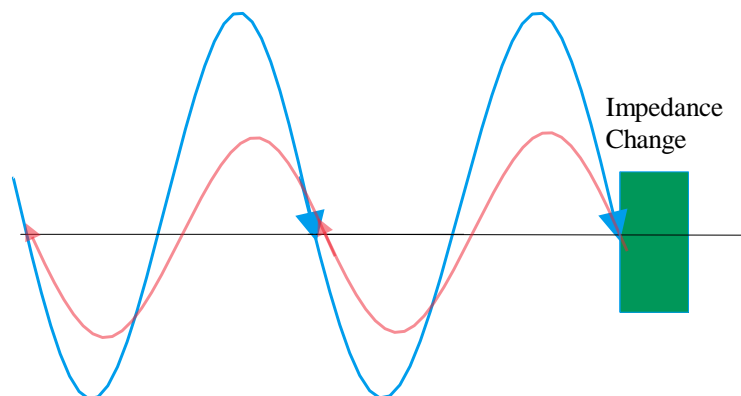

Figure 5. Discontinuities in transmission lines often cause reflections which create new signals that may interfere with and distort the desired signals.

2.4 Determining Power Using dBs

Typically signal levels for RF and microwave applications are discussed at the power level and not as voltages and currents. The power in watts is often converted into logarithms or decibels (dB).

Back in the early days calculators and spreadsheets did not exist. In order to manipulate signal levels quickly they started using dBs because you can simply add things. Rather than multiplying a ratio of 10^8 times 10^6 and factoring losses of 10^4 , the logarithmic components can simply be added. If you know the losses of your components or gain from an amplifier, one can simply add them up to get an estimated signal level.

Table 2. Power levels are easier to determine using dBs

dB	power ratio	amplitude ratio
100	10 000 000 000	100 000
90	1 000 000 000	31 620
80	100 000 000	10 000
70	10 000 000	3 162
60	1 000 000	1 000
50	100 000	316.2
40	10 000	100
30	1 000	31.62
20	100	10
10	10	3.162
3	1.995	1.413
1	1.259	1.122
0	1	1
-10	0.1	0.316 2
-20	0.01	0.1
-30	0.001	0.031 62
-40	0.000 1	0.01
-50	0.000 01	0.003 162
-60	0.000 001	0.001
-70	0.000 000 1	0.000 316 2
-80	0.000 000 01	0.000 1
-90	0.000 000 001	0.000 031 62
-100	0.000 000 000 1	0.000 01

3 System Design Blocks

Let's take a look at the key system blocks in a modern RF communication design. We will start with the transmitter which is basically our information source. Next is the antenna that is physically designed relative to the wavelength of the signal so that a standing wave on that antenna will allow propagation through space. The receiver side also has an antenna and amplifies the signal to a usable level and then the information is processed.

How far away are the transmit and receive antennas? How much antenna gain is needed? How sensitive does the receiver need to be? What are the government restrictions, if any, on the frequency, bandwidth, and power level? There are many considerations which will influence the ultimate design needs of the communication system. Table 3 highlights several key considerations that will influence your RF design.

Table 3. Potential RF Design Considerations

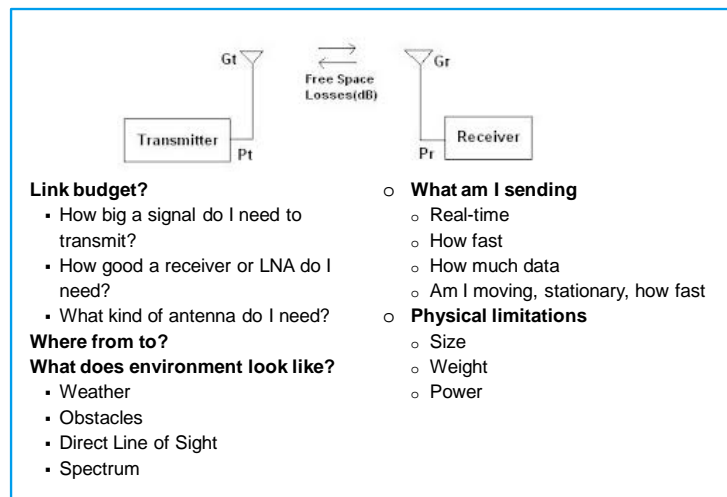

3.1 Transmitters

Figure 6 gives a high level view of the key components that make up the transmit side of a communication system. First the multiplexer is used to route the desired information into the transmit path. Signal processing is then added to condition the signal for transmission. Next the signal is modulated into whatever modulation scheme the application requires. In the early days this may have been Amplitude Modulation (AM) or Frequency Modulation (FM), today there are a wide range of digital modulation schemes with many based on Orthogonal Frequency-Division Multiplexing (OFDM) techniques.

Up to this point the signal is typically at a very low or baseband frequency. A frequency converter is used to mix the transmitted signal up to the frequency that has been allocated for the particular application. The signal level is then increased to the appropriate power level using an amplifier. Next, the signal is passed through a filter to

make sure a clean signal is transmitted and that the signal stays within the allocated frequency band. Finally the signal is radiated through the air via an antenna.

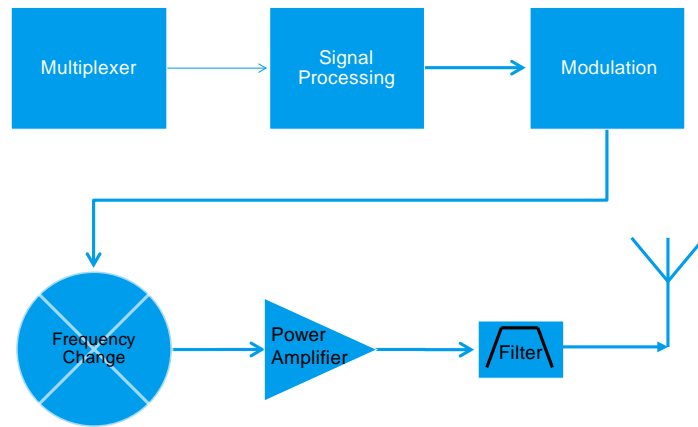

Figure 6. Simplified transmitter block diagram

3.2 Receivers

The receiver side basically has similar components but in the opposite order (Figure 7). The signal is received by the antenna and then run through a filter to eliminate all of the signals outside the frequency band of interest. As the signal is at a fairly low level, a low noise amplifier (LNA) is used to raise the desired signal above the noise floor. The signal is then down converted to a lower frequency or baseband frequency where it is then demodulated, processed and directed to the appropriate signal path for the received information.

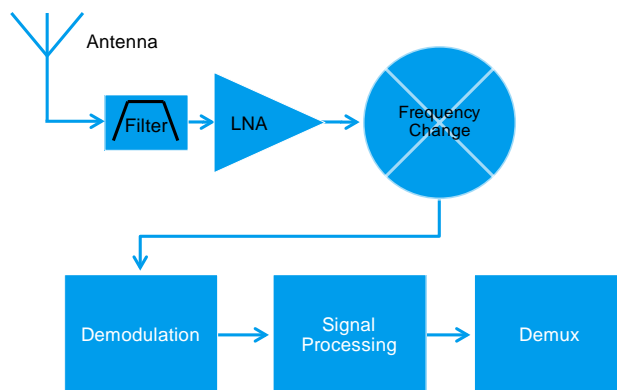

Figure 7. Simplified receiver block diagram

3.3 Antennas

Antennas are one of the key aspects of the whole communication system as they convert the electrical power into the radio waves and vice versa. Some of the key parameters for antenna include gain, directivity and return loss. These parameters determine the required size of the antenna and how directional the antenna beam must be. Many antennas, such as those found on mobile phones and GPS devices, are isotropic in that they send energy equally in all directions. Satellite dishes and base station antennas are good examples of fairly focused antenna beams which may be used over long distances in fixed position applications (Figure 8). Antennas are evaluated at an antenna test facility where their beam patterns are measured by rotating the antenna through 360 degrees in both horizontal and vertical planes while measuring power levels (Figure 9).



Figure 8. Antennas come in all shapes and sizes

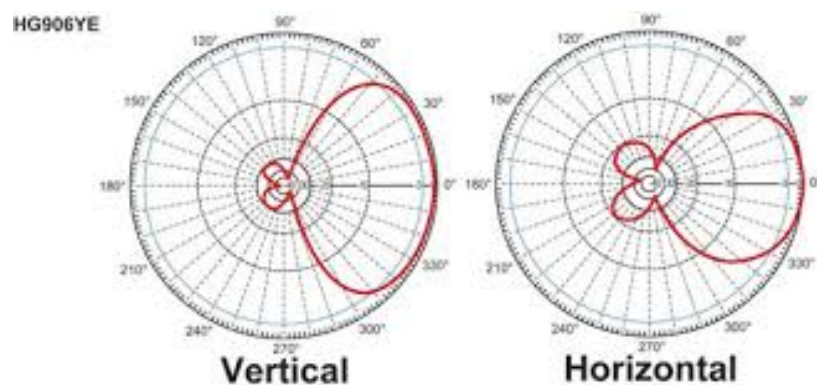

Figure 9. Antenna performance is evaluated by measuring the beam patterns in both the vertical and horizontal planes.

3.4 Putting It All Together

Today, in many cases, one doesn't have just a transmitter or a receiver. Many devices are two-way such as your mobile phone, laptop or tablet. Each of these devices actually contains transmitters, receivers and a series of antenna. These devices create a new set of challenges in designs that try to minimize signals bleeding into different sections. Future courses will cover these types of designs in more detail.

4 Components

Next let's look at a few of the key components that we discussed at the system level. The design or selection of these components must be clearly understood to ensure that the system meets the need for the specific application.

4.1 Filters

As we discussed earlier, filters play an important role in both transmitter and receiver design. On the transmit side it is critical that the radiated signals adhere to the FCC guidelines for a particular application. On the receive side it is important that all extraneous signals that are picked up by the receive antennas are filtered out to achieve optimum signal quality of the desired signal.

There are many different types of filters including low pass, high pass and band pass. The low/high pass designs basically filter out all frequencies above/below the designed frequency. A band pass filter restricts frequencies to a particular frequency band (Figure 11).

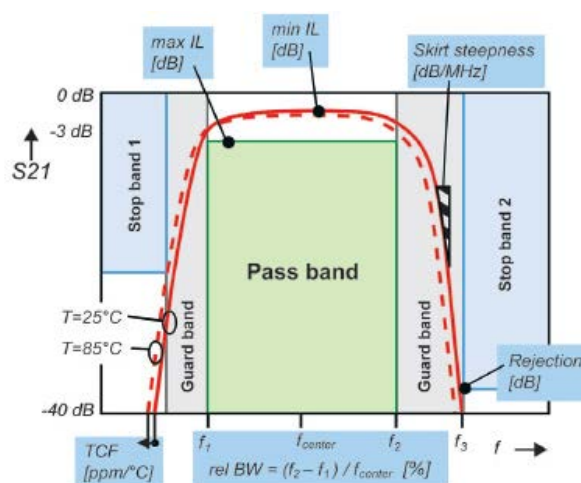

Figure 11. Illustration of a band pass RF filter performance characteristics

The In-band or pass band performance is specified to minimize degradation to the desired frequencies. The bandwidth is defined by either (or both) the 3 dB and/or 1 dB drop in signal level on either side of the center frequency. The amount of lost power or insertion loss across the desired frequency range is another critical parameter. Finally, how much variation or ripple is caused to the magnitude of the signal and the same for the phase response across the pass band?

For out-of-band performance the critical parameter is with regards to how much the filtered signal is reduced. There may be different levels of performance based on distance from the filter's center frequency.

4.2 Amplifiers

Amplifiers are also often located in both transmitter and receiver designs, however they have very different roles and performance requirements.

On the transmitter side, the desired signal has been created and is very well defined. Power amplifiers (PAs) are used to increase the signal level to the required power range to allow the radiated signal to be received at the other end, as well as meet the FCC requirements. The PA may be used in either the linear or nonlinear region. In the linear region, an increase in input signal yields a defined increase in the output signal, this is referred to as gain. However, at some point the input signal becomes large enough that the output starts to increase but at a different rate. This is commonly referred to as the non-linear region. The rate of roll off in the gain vs. power measurement is known as the 1dB compression point.

Amplifiers operating in their non-linear region often have their harmonic and spurious signals specified. Amplifiers designed to operate at a specific center frequency, F_c , will also radiate at multiples of the center frequency - $2F_c$, $3F_c$ and so on. In addition, spurious signals may be generated from the transmitter components such as the power supply and amplified by the PA. Amplifier designs try to minimize these effects and the filters that were previously discussed are also key in minimizing these effects.

The Adjacent Channel Power Ratio (ACPR) is typically specified to ensure that the radiated signal stays within its given channel and does not spill into the adjacent channel. The entire allocated spectrum for a technology, such as Wi-Fi is divided up into channels to increase traffic capacity. It is important that signals stay within their specified channel and do not leak signals into other channels.

Dynamic range is usually specified to let system designers know what the minimum and maximum level signal is that can be transmitted.

On the receiver side the antenna is bringing in both the desired signals and also unknown signals over-the-air. These signals tend to be at lower power levels and may need to be boosted to separate from the noise floor. These amplifiers are often Low Noise Amplifiers (LNAs).

Over-the-air there is something that is referred to as thermal noise or kTB , where k is Boltzmann's constant, T is the absolute temperature of the load (for example a resistor), and B is the measurement bandwidth. The standard number we use for that is -174 dBm per hertz, which is the noise floor relative to a one hertz bandwidth. The goal of the LNA is to raise the signal above this noise level so that it can accurately be used. One of the key specifications of an LNA is its noise figure. The noise factor is the ratio of actual output noise to that which would remain if the device itself did not introduce noise, or the ratio of input SNR to output SNR. The noise figure is the noise factor expressed in decibels (dB)

4.3 Mixers

Mixers are the component involved in the frequency up or down conversion in the transmitter/receiver design. On the transmit side the created signal or baseband signal is feed into one arm of the mixer. On the other is a local oscillator (LO) that is designed to mix the baseband signal to the appropriate frequency to be radiated via the third arm to the antenna. On the receiver side it is the same except for the reverse direction. The LO is used to mix the RF signal down to baseband.

The mixer produces not only the product of the baseband and LO frequencies but also the difference of the two frequencies. As the mixer is a non-linear device, it also creates the harmonics of both the product and difference signals. Based on the design of the mixer, certain levels of both the input signal and the LO signal may “bleed through” the mixer and be part of the output signal as well (Figure 12).

While mixers play a critical role of moving signals to the proper frequency range, they can also be contributors for noise into the desired signal. Filtering plays a key role for reducing the effects created by unwanted mixer products.

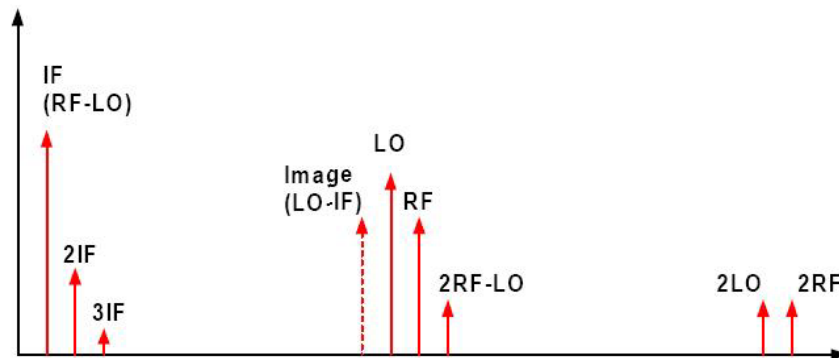

Figure 12. Mixer spectral output

4.4 Modulators/Demodulators

The modulator/demodulator basically adds or extracts the information into the signal that will be either transmitted or received. Typically the modulation involves adding information to any or all of these parameters:

- Frequency
- Amplitude
- Phase

In the early days modulation formats were analog, such as TV, radio and the early mobile phones. Analog modulated signals are continuous variations to the carrier wave. Modern wireless signals typically use digital modulation techniques. For digital modulation, signals at different states exist which represent sequences of bits. Further discussions on modulation techniques will be covered in more detail in a future paper.

5 Test and Verification Instrumentation

Throughout the design process it is important to evaluate the performance of your components and systems. Rohde & Schwarz offers test equipment that will verify your designs from prototypes through manufacturing and even field operations. This test equipment can be used to verify not only the total performance of the system, but can also be used to replace parts of the system which may not be available at test time. This section provides a brief review of the most common types of test equipment for performing this verification.

5.1 Spectrum Analyzers

The testing of a transmitting device or subsystem generally requires a receiver of some sort. Spectrum analyzers have been designed specifically for this purpose and are one of the most common pieces of test equipment that will be found in an RF lab. A spectrum analyzer is a basic measurement device that is required if looking at complex signals or where multiple signals are being used. The basic measurement is frequency versus power.



Modern versions have many new capabilities for measuring including:

- Noise Figure
- Group Delay
- Phase Noise
- Basic Modulation Analysis
- Complex Modulation Analysis for:
 - Mobile Wireless
 - Wireless LAN
 - Bluetooth
 - Satellite Communications
 - RADAR

5.2 Signal Generators

Signal generators are used to represent the transmitter by creating the required signals with the proper modulation formats. They are used as a basic measurement device when required to generate simple and complex input signals. There are two main types: analog and vector. The analog signal generator is used to create basic sine waves at different power levels and frequencies. They typically have basic modulation capabilities such as AM, FM, phase and pulse. Vector signal generators are used to create the more complex digitally modulated signals that are quite common these days.



Modern versions have many new capabilities for generating complex signals including:

- AM, FM, PM
- Arbitrary signals generated mathematically
- Frequency hopping signals
- Complex Modulation Signals including:
 - Mobile Wireless
 - Wireless LAN
 - Bluetooth
 - Satellite Communications
 - RADAR

5.3 Vector Network Analyzers

Vector network analyzers (VNAs) are used primarily for verifying component level performance. The VNA is a more complex measurement device used to stimulate and measure amplitude and phase response of high frequency devices. Basic use is to stimulate a device such as an amplifier with a sine wave and measure the amplitude and phase response. Network analyzers typically measure the Scattering parameters or S-parameters as signal power and energy considerations are more easily quantified than currents and voltages.



Modern versions have many new capabilities for measuring more complex parameters or devices such as:

- Balance/differential and true differential
- Non-linear characteristics
- Impedance matching
- Mixers or converters
- Multiport devices up to 48 ports

5.4 RF Power Meters / Sensors

A power meter is one of the most fundamental measuring tools that simply measures the power level coming out of a device. There are typically two types:

- Diode Based – high dynamic range
- Thermistor Based – more accurate but lower dynamic range

Power meters do not provide information as to the frequency content. Newer power meters typically include sensor with PC software based measurement unit. They can be used in for example in conjunction with a signal generator to get the basic frequency response of devices. Many modern versions also have the ability to measure pulsed or bursted signals.



6 Conclusion

This is intended to be the first in a series of papers on the process of RF system design. RF system design is a complex process beginning with a detailed understanding of many things such as:

- Operating environment
- Size, weight, power
- What information to be sent
- One-way or two way
- Stationary or moving
- Target cost
- Available spectrum or frequency

After a system is conceptualized, it is typically simulated. Finally a prototype needs to be built and its performance validated.

About Rohde & Schwarz

Rohde & Schwarz is an independent group of companies specializing in electronics. It is a leading supplier of solutions in the fields of test and measurement, broadcasting, radiomonitoring and radiolocation, as well as secure communications. Established more than 75 years ago, Rohde & Schwarz has a global presence and a dedicated service network in over 70 countries. Company headquarters are in Munich, Germany.

Regional contact

North America
1-888-TEST-RSA (1-888-837-8772)
customer.support@rsa.rohde-schwarz.com

Europe, Africa, Middle East
+49 89 4129 12345
customersupport@rohde-schwarz.com

Latin America
+1-410-910-7988
customersupport.la@rohde-schwarz.com

Asia/Pacific
+65 65 13 04 88
customersupport.asia@rohde-schwarz.com

China
+86-800-810-8228 /+86-400-650-5896
customersupport.china@rohde-schwarz.com

Environmental commitment

- Energy-efficient products
- Continuous improvement in environmental sustainability
- ISO 14001-certified environmental management system



This white paper and the supplied programs may only be used subject to the conditions of use set forth in the download area of the Rohde & Schwarz website.

R&S® is a registered trademark of Rohde & Schwarz GmbH & Co. KG; Trade names are trademarks of the owners.

